

dametric 

## DSI-02

VAL0122843 / SKC9302132

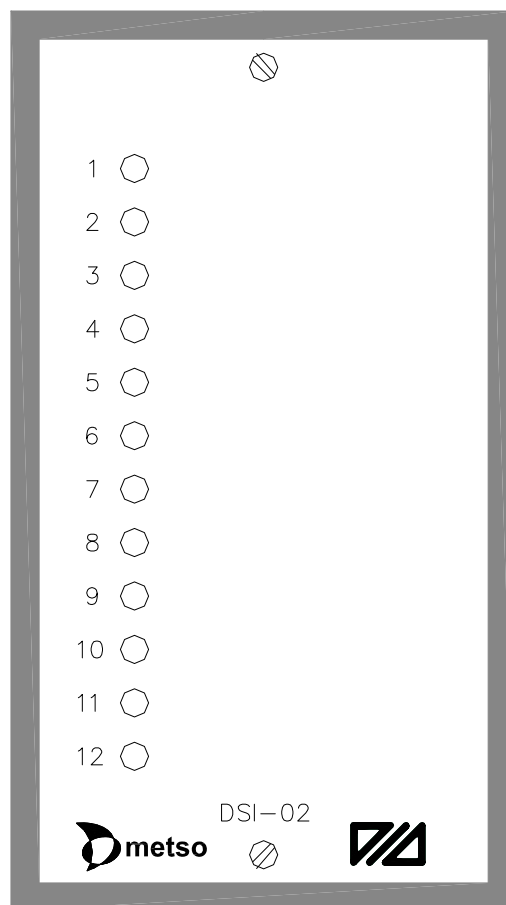

DIGITAL SIGNAL INDIKATOR, 115VAC  
ANVÄNDARBESKRIVNING

Valmet 

### 1 TEKNISK SPECIFIKATION

Artikelnummer: DSI-02 / VAL0122843 / SKC302132

**Signalingångar**

Antal signalingångar: 12 st  
 Indikering: Röd lysdiod, dia = 5 mm  
 Nominell signalspänning: 115 Vac  
 Nominell signal ström: 10 mA  
 Anslutning: 12-pol skruvplint

**Testingång**

Nominell signalspänning: 115 Vac  
 Nominell signal ström: 120 mA  
 Anslutning: 2-pol skruvplint

**Kapsling**

Yttermått: Bredd = 90 mm, Höjd = 160 mm, Djup = 37 mm  
 Täthet: IP65 från framsidan,

### 2 KOMPONENTPLACERING

### 3 KRETSSCHEMA

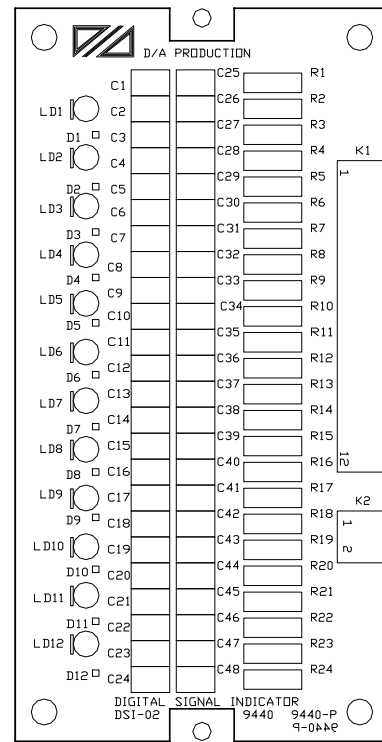
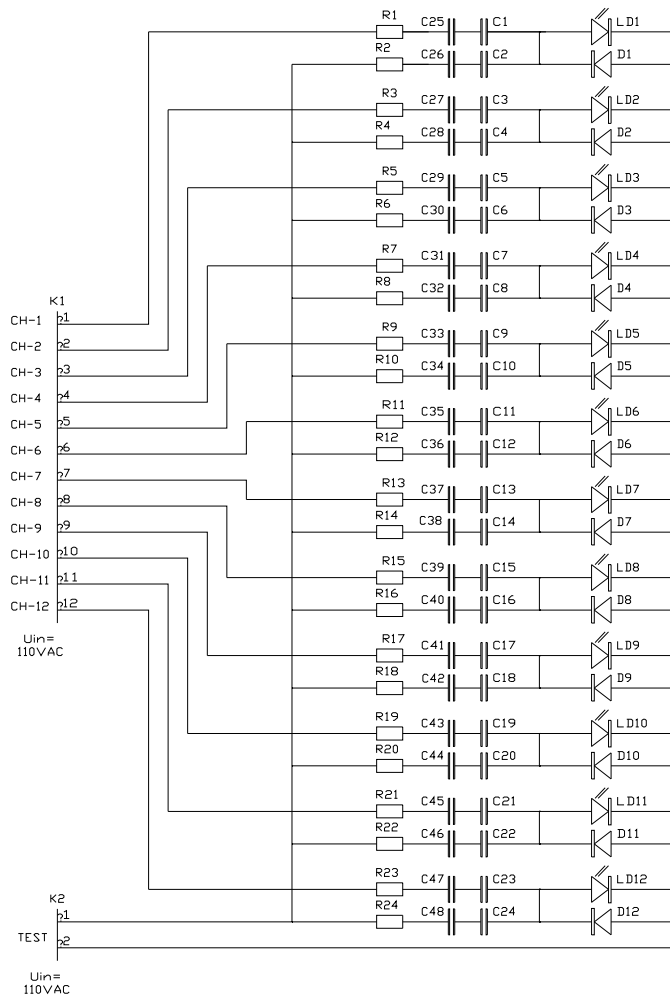

4 KONTURRITNING

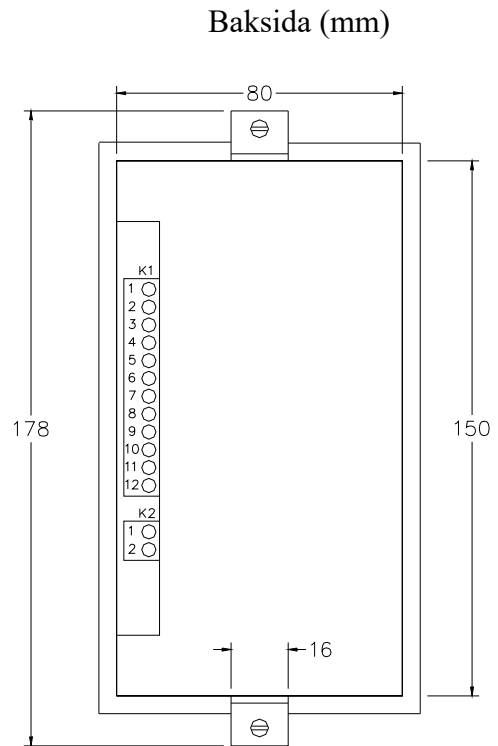
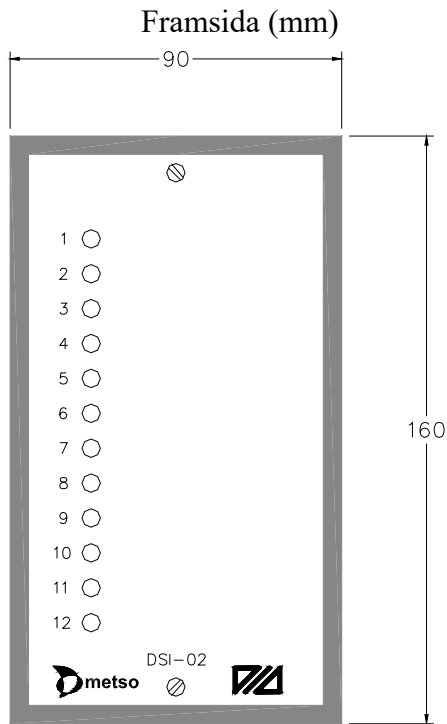

Sida (mm)

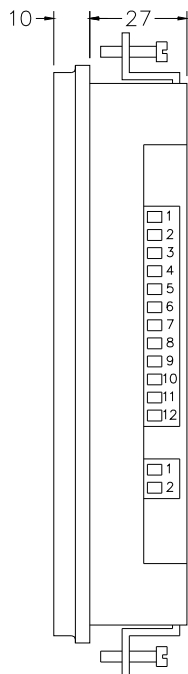

Håltagning i panel (mm)

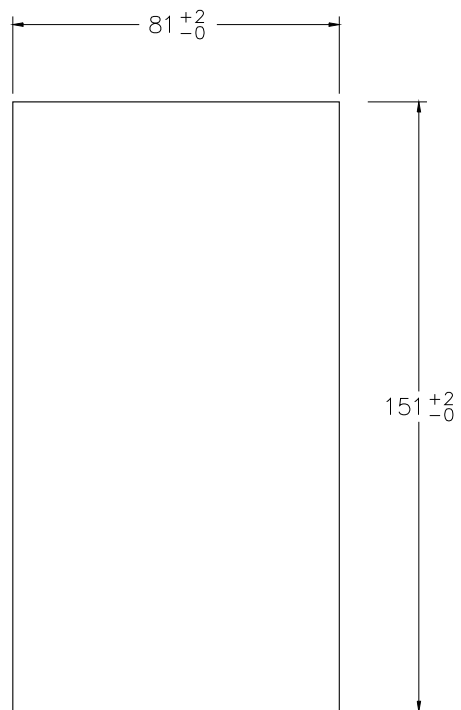

## 5 KONTAKT

Utveckling, produktion och underhåll:

### Dametric AB

Jägerhorns Väg 19, 141 75 Kungens Kurva

Telefon: 08-556 477 00

Telefax: 08-556 477 29

E-post: [service@dametric.se](mailto:service@dametric.se)

Websida: [www.dametric.se](http://www.dametric.se)

dametric 

Valmet 